

HiSazo

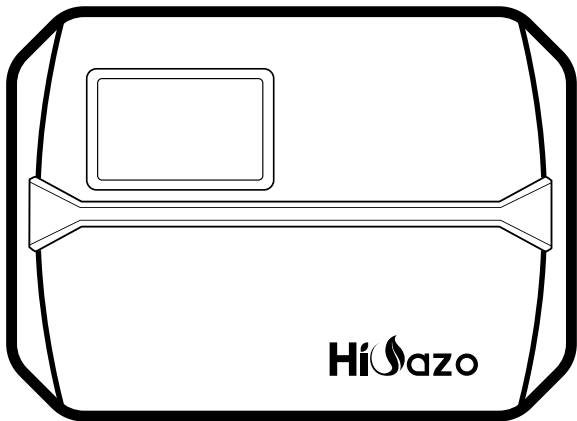

**SMART SPRINKLER
CONTROLLER**

HSC-800W

U S E R M A N U A L



Please keep this manual properly for reference. You can also scan the QR code to visit our official website for product usage videos. For any usage issues, please feel free to contact us at **support@hioazo.com**.

Wenn Sie eine Bedienungsanleitung in deutscher Sprache benötigen, scannen Sie bitte den QR-Code und besuchen Sie unsere Website, um sie zu erhalten und ein Video über die Verwendung des Produkts zu sehen.

Se avete bisogno di un manuale di istruzioni in italiano, scansionate il codice QR e visitate il nostro sito web per ottenerlo e vedere un video su come utilizzare il prodotto.

Si vous avez besoin d'un mode d'emploi en français, veuillez scanner le code QR pour visiter notre site officiel afin d'obtenir et de visionner la vidéo d'utilisation du produit !

Als je een Nederlandstalige handleiding nodig hebt, scan dan de QR-code om naar onze officiële website te gaan en bekijk de video over het gebruik van het product!

Si necesita el manual de instrucciones en español, escanee el código QR para ir a nuestro sitio web oficial y ver el vídeo sobre cómo utilizar el producto.



Warm tips

- To quickly jump to a specific chapter page, click on the relevant text on the contents page.
- You can also use the thumbnail or document outline in the top left corner to quickly find a specific page.

CONTENTS

01	WHAT YOU WILL GET?	5
02	TOOLS YOU WILL NEED	6
03	PRODUCT DIAGRAM	8
04	INSTALLATION STEPS	9
05	TROUBLESHOOTING GUIDE	17
06	FUNCTION DESCRIPTION	18
07	FCC REQUIREMENT	18
08	CUSTOMER SERVICE	19

01 WHAT YOU WILL GET?

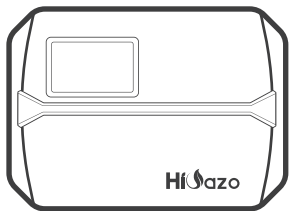

Magnetic Faceplate

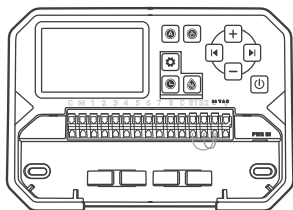

Smart Sprinkler Controller

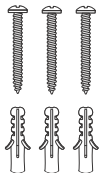

3x Screws with Anchors

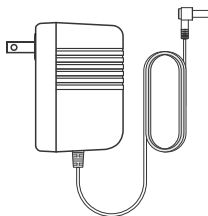

Power Adapter



Screwdriver

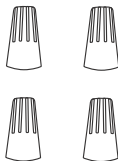

Threaded Wiring Connectors(4PCS)

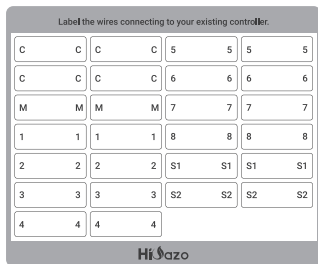

Label Sticker

02 TOOLS YOU WILL NEED



2.4Ghz Wi-Fi Access



Smartphone or Tablet



Screwdriver



Hammer

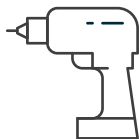

Electric Drill

● Electrical Specifications

<i>Adapter Input</i>	<i>US - AC120V 60Hz AU - AC230~240V 50Hz EU - AC230V 50Hz UK - AC240V 50Hz</i>
<i>Adapter Output</i>	<i>AC24V 1000mA</i>
<i>Controller Input</i>	<i>AC24V 1000mA</i>
<i>Zone Output</i>	<i>Compatible with AC24V control valve</i>
<i>Master/Pump Valve Output</i>	<i>AC24V</i>

● App Installation Requirements

- iOS or Android compatible device (iOS 13/Android 7.1 and later)
- 2.4GHz wireless network signal available at the installation location
- Support WEP/WPA/WPA2/WPA2 PSK(AES) security modes

● Product Dimensions

- Controller Size: 7.9inch*5.7inch*1.8inch/201mm*145mm*46mm
- Product Weight: 16.5oz/468g

03 PRODUCT DIAGRAM

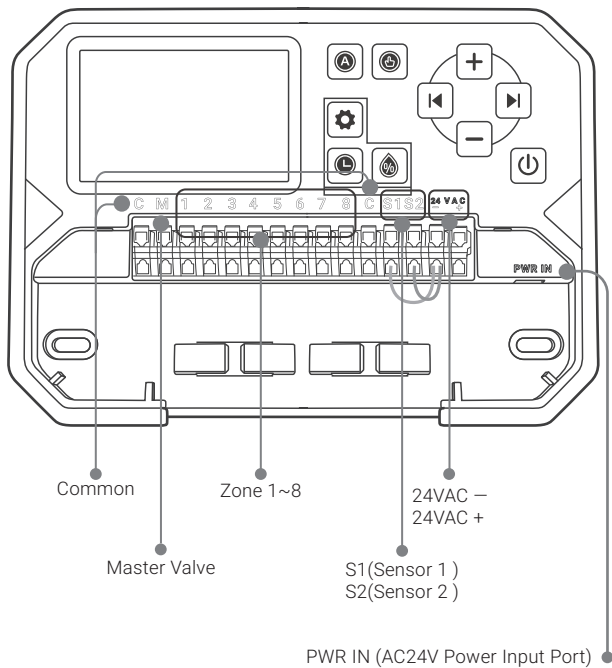

04 INSTALLATION STEPS



- Before installation, ensure that the device can connect to WiFi without any issues.

Step 1: Download the APP

Search the keyword "HiOazo" in App Store or Google Play, or scan the QR code to download and install the APP. Create your account once the App is installed.



Step 2: Connect to Wi-Fi

Plug the device into a power socket, and the LCD will fully light up for one second. After waiting for 5 seconds, the  character will flash, indicating that the device has entered the WiFi connection state. If the  character light does not flash, press and hold the  button for two seconds to reset the WiFi connection.

Open the HiOazo app and click "+" on the top right corner to add a device. Then, follow the app instructions to complete the Wi-Fi connection. Note that this controller only supports 2.4GHz Wi-Fi networks. After the connection is successful, the  indicator on the controller will always be on.

Congratulations! You have successfully connected the product to WiFi! Please follow the steps below to complete the installation.

Step 1: Remove your old controller

First, test your old system to ensure all the sprinklers work properly. Then label each wire using the included label stickers to avoid confusion.

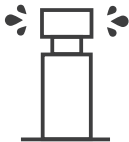

Check all sprinklers



Mark all wires

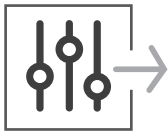

Remove old controller

Step 2: Mark Screw Locations

1. Please make sure the distance between the device and the power socket is under 6 feet (1.8 meters).



2. Use the mounting template to mark the location for installation. Then use the electric drill to drill holes in the marked mounting locations. Finally, use the hammer to install the screw anchors to the wall.

3. Secure the top screw. Pay attention to leave a proper distance between the nut and the wall for hanging the controller.

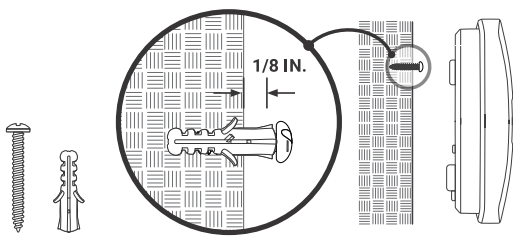

Step 3: Install Your New Controller

Hang your new controller on the nut. Then secure the controller with two screws at the bottom.

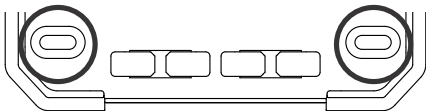

Step 4: Wire Connection

Insert the wires into the appropriate terminals.

C**Common Wires**

Common wires are usually labeled "C", insert them into any of the "C" terminals.

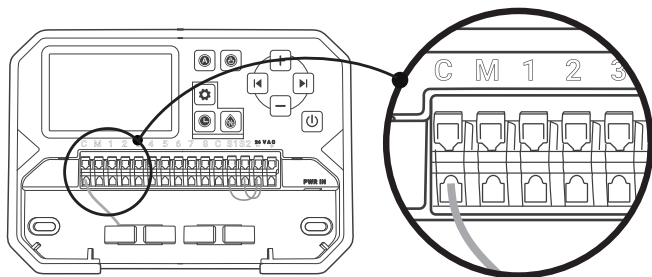
**M****Master valve /Pump start relay****1.Master valve (optional)**

Master valve wires are usually labeled "M". Wire the master valve into the "M" terminal if you have one.

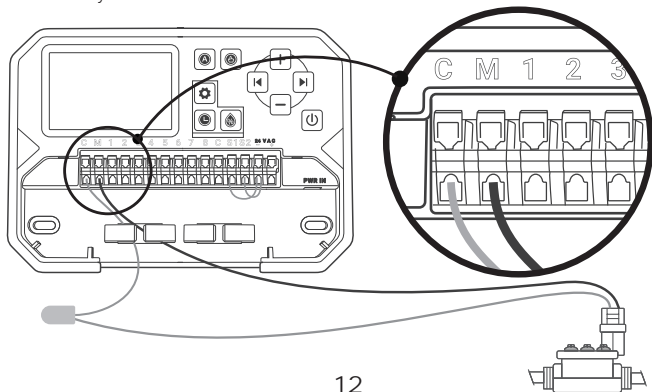

2. Pump start relay (optional)

A water pump extracts water from a well or other water sources. If you want to start a water pump via the controller, a pump start relay is necessary. Pump start relay wires are usually labeled “Pump”. Please wire it into the “M” terminal.

Note: The pump should never be wired directly to the controller, doing so will damage your controller, as well as void your warranty.

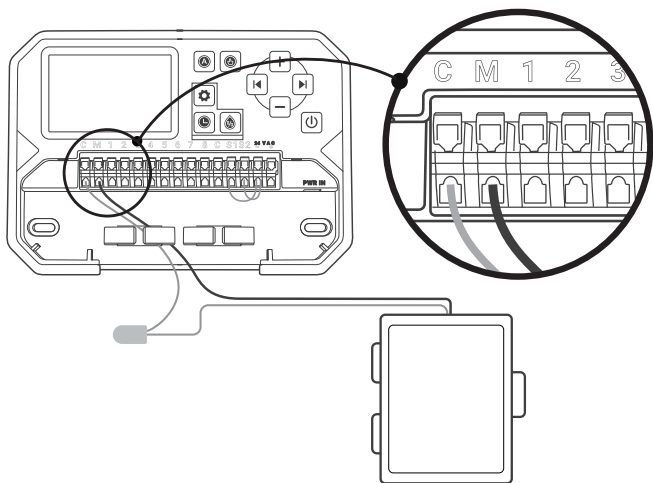

Pump Start Relay

Zone Wires correspond to the landscape's zones, insert them into the terminals 1~8.

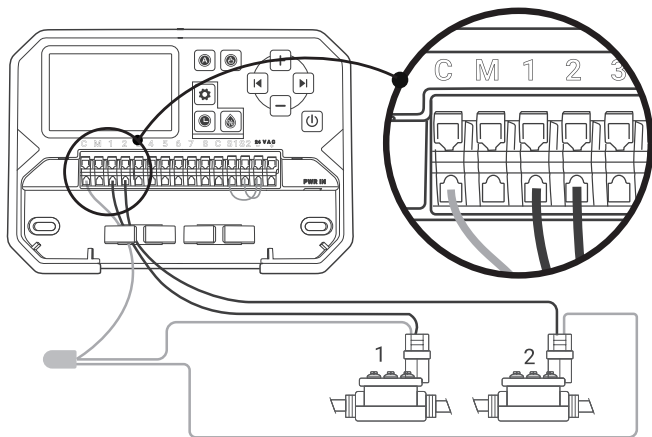

S1**S2****Rain sensor (optional)**

Rain sensor wires are usually labeled "S1" "S2", wire it into the "S1" or "S2" and "24-" terminals. You can connect up to 2 rain sensors.

If you are running a rain sensor. "24-" terminal equals to the "C" terminal.

Note: Please enable the rain sensor on the app if you are running a rain sensor.

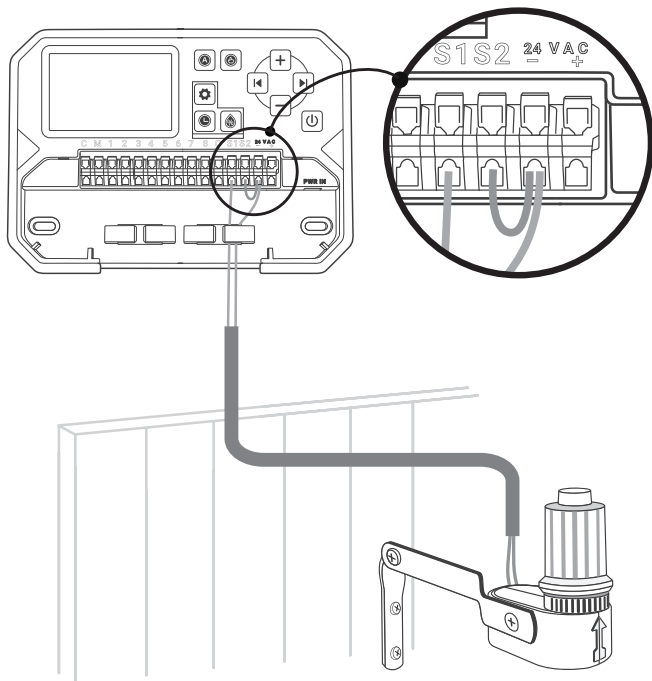

PWR IN**Power-in**

Insert the power connector upwards into the power jack . Then plug the adapter into a power outlet.

Note: Please do not turn on the power before all wires are well connected. Please cut off the power of the controller if any wire is damaged. In that case, we recommend replacing the damaged wire to avoid hazards.

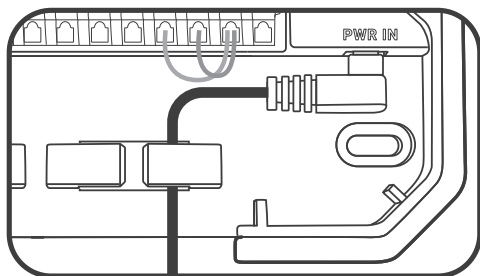

Congratulations! You are now ready to use the new controller! Let's start a new irrigation journey!



Remotely control
your device





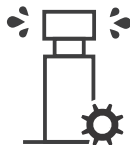

Create your smart
IoT home









Optimize your
watering schedule

05 TROUBLESHOOTING GUIDE

What can you do if the Wi-Fi connection or irrigation facilities are not working? Here are some possible reasons and relative solutions for reference. We hope they are helpful. For any further questions, please feel free to contact us at support@hioazo.com.

WiFi Connection Issue	<ol style="list-style-type: none">1. Ensure the 2.4GHz WiFi signal is enabled on your router (it may need to be open in the router settings)2. Ensure the controller is within range of a stable and strong 2.4 GHz signal.3. Ensure your smartphone has Bluetooth enabled. With Bluetooth assistance, the controller can be connected faster.4. Ensure the controller is in the pairing mode, with the WiFi icon  flashing. Otherwise, please press and hold the  button for 2 seconds to enter pairing mode
Device Issue	<ol style="list-style-type: none">1. The LCD does not light up, please check if the power adapter is fully inserted into the power jack or if the power outlet is on.2. The controller does not activate the sprinkler to water, please check all the valves are wired to the controller correctly and the valves are compatible with 24V AC.
Setting Issue (How to enter pairing mode/reset WiFi?)	Press and hold the  button for 2 seconds, and the  will flash.

06 FUNCTION DESCRIPTION

Function	Button Press
Manual Watering	Press  to display "ALL", prompting all zones to be executed simultaneously; Press +/- to select the desired zone and press to set the watering duration. Press +/- to adjust the number. Then press  to start the watering.
Skip	During watering, press  to cancel watering in this zone.
Obey/ignore the rain sensor	In AUTO mode, press and hold  for 2 seconds to obey/ignore the rain sensor. When IGNORE is selected, the icon  is displayed.
OFF	Short press  to power off. Only character "OFF" is displayed.
Factory Settings	Press and hold  for 5 seconds until you hear a BEEP sound to restore factory settings.

07 FCC REQUIREMENT

Changes or modifications not expressly approved by the party responsible for compliance could void the user's authority to operate the equipment. This device complies with Part 15 of the FCC Rules. Operation is subject to the following two conditions:

- (1) this device may not cause harmful interference, and
- (2) this device must accept any interference received, including interference that may cause undesired operation.

Note: This equipment has been tested and found to comply with the limits for a Class B digital device, pursuant to Part 15 of the FCC Rules. These limits are designed to provide reasonable protection against harmful interference in a residential installation. This equipment generates, uses, and can radiate radio frequency energy, and if not installed and used in accordance with the instructions, may cause harmful interference to radio communications. However, there is no guarantee that interference will not occur in a particular installation. If this equipment does cause harmful interference to radio or television reception, which can be determined by turning the equipment off and on, the user is encouraged to try to correct the interference by one or more of the following measures:

- Reorient or relocate the receiving antenna.
- Increase the separation between the equipment and receiver.
- Connect the equipment into an outlet on a circuit different from that to which the receiver is connected.
- Consult the dealer or an experienced radio/TV technician for help.

This equipment complies with FCC radiation exposure limits set forth for an uncontrolled environment. This equipment should be installed and operated with a minimum distance of 20cm between the radiator & your body. This transmitter must not be co-located or operating in conjunction with any other antenna or transmitter.

08 CUSTOMER SERVICE

This item carries a 2-year warranty against defects in either components or workmanship. During this period, products that prove to be defective will, at the discretion of HiOazo, be either repaired or replaced without charge. For any problems in use, please feel free to contact us at support@hioazo.com. We will do our best to help you.

support@hioazo.com

Manufacturer: Shenzhen Chunwo Technology Co.,Ltd.

Factory Address: Room 319-5, Area D, 3rd Floor, Building A, Tengfei Industrial Building, No.6 Taohua Road, Fubao Community, Fubao Street, Futian District, Shenzhen

Distributor: DongGuan YingMeng Technology Co., Ltd.

Address: No.118 Fengping Road, Fenggang Town, Room 101, Building 2, Dongguan, Guangdong



V1.0

MADE IN CHINA